

# specs

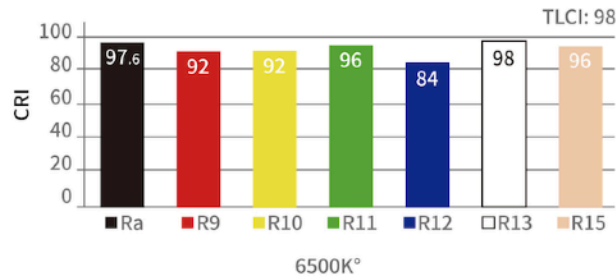

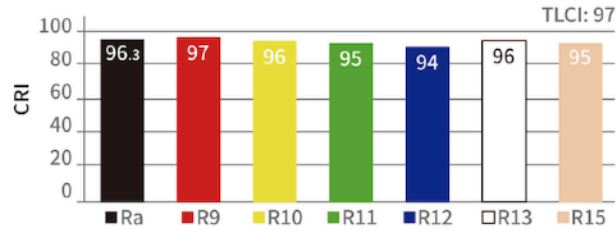





light source: WW-CW LED  
 CCT: 2700K-6500K  
 illuminance: 0.5m 9700lux/1m 3950lux/2m 1077lux  
 wattage: 200W  
 color rendition: CRI98  
 balloon dimensions: 1350mm x 600mm x 200mm

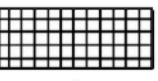

# Safety Notices

1. Please use only in environment between -10 and 40 degrees Celsius.
2. Please only use fixture with the controller in the kit and according to the manual within the range of compatible voltage and temperature, failure to do so might cause damage to the fixture.
3. This product is not water proof. Please beware in case of rain or damp environment.
4. Please do not use near chemical hazard, inflammable gas or other dangerous matter as it may cause potential fire or electromagnetic interference. Please be ware of warning signs in situations that may apply.

# packaging list

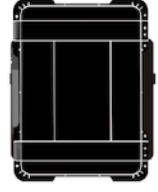
- |                       |    |  |   |
|-----------------------|----|--|---|
| ① lighting balloon    | x1 |   |  |
| ② controller          | x1 |  |   |
| ③ 7m controller cable | x1 |   |  |
| ④ 3m power cable      | x1 |  |   |
| ⑤ eggcrate            | x1 |   |   |
| ⑥ mounting brack      | x1 |   |   |
| ⑦ shoulder strap      | x1 |  |   |
| ⑧ air pump            | x1 |  |   |
| ⑨ safety case         | x1 |  |   |

# FLYNOODLE<sup>®</sup> Air Light User Manual



# connecting instructions

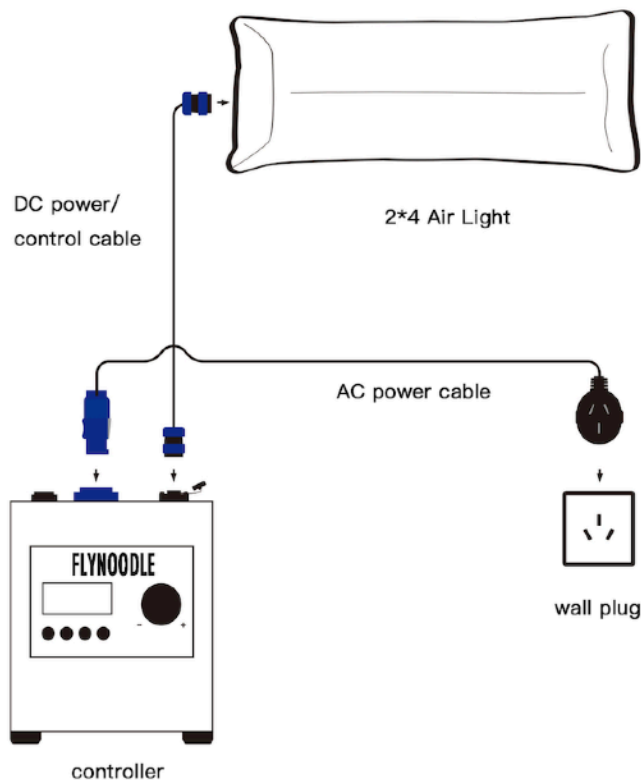

# connectors & buttons



## power controller

- o — power off
- I — V mount batter power mode
- II — AC power mode



## head power input



## multi-function

- press to switch between CCT and dimmer mode
- rotate to adjust levels



## CCT /Dimmer control buttons

- M — CCT mode /dimmer mode
- ▲ — CCT/intensity adjustment
- ▼ — CCT/intensity adjustment
- C — undecided



## AC power input



## air valve on the balloon & protection cap for air valve

# Air Inflation

- 1.rotate the air valve protection cap counterclockwise
- 2.press and rotate the air valve clockwise, confirm that the air valve has popped out
- 3.plug the air nozzle into the air outlet on the pump and plug into AC power.
- 4.connect the air nozzle to the valve, align the notch and rotate the nozzle clockwise.
- 5.switch on the electrical air pump until the AirLight is fully inflated, and rotate the nozzle counterclockwise
- 6.secure the protection cap by rotating clockwise.

# deflation

- 1.rotate the air valve protection cap counterclockwise.
- 2.press and rotate the air valve counterclockwise, confirm that the valve is pressed in.
- 3.plug the air nozzle into the air outlet on the pump and plug into AC power.
- 4.connect the air nozzle to the valve, align the notch and rotate the nozzle clockwise.
- 5.switch on the electrical air pump until the AirLight is fully deflated, and rotate the nozzle counterclockwise
- 6.secure the protection cap by rotating clockwise.

Tichuan International Co.,Ltd  
Website: <https://www.ti-chuan.com>  
Email: [contact@ti-chuan.com.cn](mailto:contact@ti-chuan.com.cn)  
Mobile:0086 18626302806  
Address: No.29-2 Luou Road,Hudai Industry Park,  
Binhu District,Wuxi city 214126

Online:  
Skype: forestchina1983  
QQ: 718782827  
Wechat|Whatsapp: 0086 18626302806  
Technical Support:  
[support@ti-chuan.com](mailto:support@ti-chuan.com)

